

INSTRUCTION MANUAL

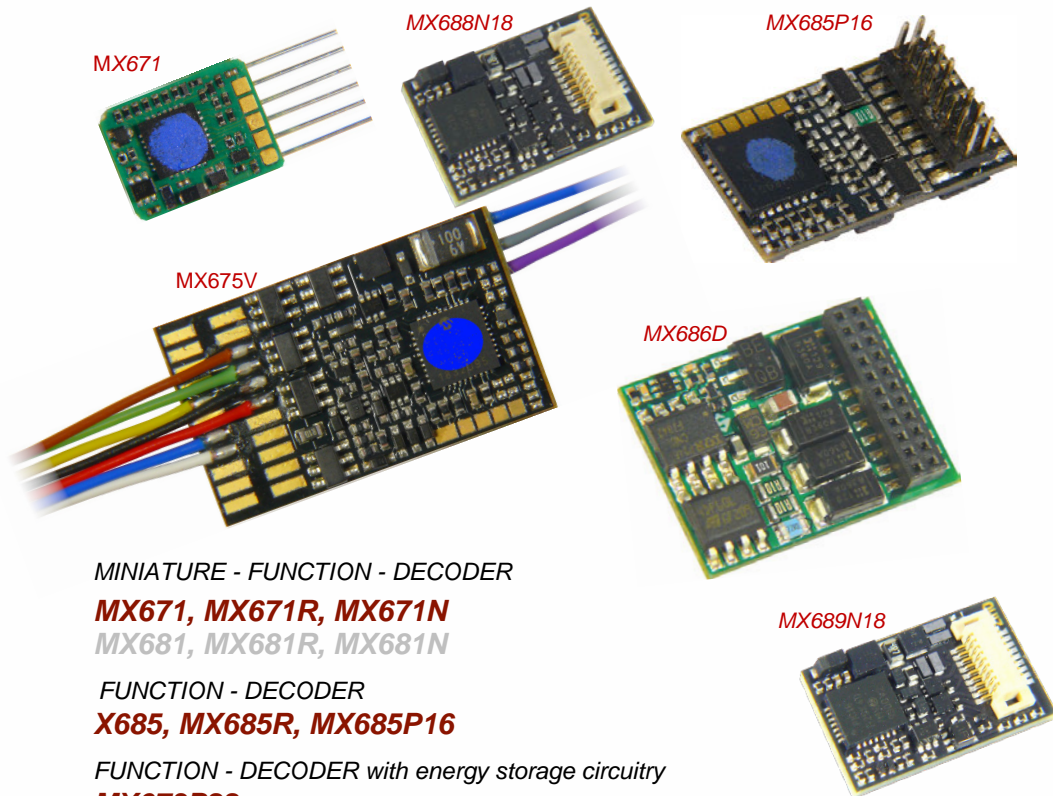

MINIATURE - FUNCTION - DECODER

MX671, MX671R, MX671N
 MX681, MX681R, MX681N

FUNCTION - DECODER

X685, MX685R, MX685P16

FUNCTION - DECODER with energy storage circuitry

MX673P22

MX686D, MX686

FUNCTION - DECODER with energy storage circuitry and low-voltage output

MX675V, MX675VP22, MX676VD

MX687V, MX687W, MX687WD

FUNCTION - DECODER with NEXT-18 interface

MX688N18

MX689N18 Flat build (only one side equipped)

Printed in GREY are the types that are not being produced anymore.

FUNCTION DECODERS

EDITION

First edition	---	2011 08 15
		2012 08 15
		2015 01 25
		2015 02 05
MX688N18 supplement	---	2015 11 16
Swiss Mapping	---	2016 06 23
		2018 05 25
		2018 07 11
		2022 01 18
		2022 02 16
		2022 02 24

1	Overview	2
2	Technical Information	3
3	Addressing and Programming	7
3.1	Programming in "Service mode" (on programming track)	7
3.2	Programming in "Operational mode" (a.k.a. on-the-main, "PoM")	7
3.3	Decoder-ID, Load -Code, Decoder-Type and SW-Version	8
3.4	The (first) vehicle address	8
3.5	The second address in a function decoder	9
3.6	Analog operation	9
3.7	"Virtual" motor control and momentum	10
3.8	The NMRA-DCC function mapping	12
3.9	"Unilateral Light Suppression"	13
3.10	The "Swiss Mapping" (SW version 32 and later)	13
3.11	Dimming, Low beam and Direction Bits.....	14
3.12	The Flasher Effect.....	15
3.13	F1- Pulse Chains (Only for old LGB products)	15
3.14	Special Effects for Function Outputs (US and other lighting effects, Smoke generator, ...) ..	16
3.15	Configuration of Electric Uncouplers	17
3.16	SUSI-Interface and Logic-Level Output.....	17
3.17	Servo Configuration	17
3.18	Low-Voltage for Function Outputs (only function decoder MX675, MX676).....	18
4	Feedback - "Bidirectional communication"	18
5	Operating with Märklin MOTOROLA Systems	19
6	ZIMO Decoder - Software Update	19
7	Calculation of the long second loco address:	19
8	Service Notes	19
9	Declaration of conformity	20

NOTE:

ZIMO decoders contain an EEPROM which stores software that determines its characteristics and functions. The software version can be read out from CV #7 and #65. The current version may not yet be capable of all the functions mentioned in this manual. As with other computer programs, it is also not possible for the manufacturer to thoroughly test this software with all the numerous possible applications. Installing new software versions later can add new functions or correct recognized errors. SW updates can be done by the end user for all ZIMO decoders since production date October 2004, see chapter "Software Update"! Software updates are available at no charge if performed by the end user (except for the purchase of a programming module); Updates and/or upgrades performed by ZIMO are not considered a warranty repair and are at the expense of the customer. The warranty covers hardware damage exclusively, provided such damage is not caused by the user or other equipment connected to the decoder. For update versions, see www.zimo.at.



1 Overview

Function decoders are **locomotive decoders for non-motorized vehicles** and are therefore not equipped with a motor end stage but do offer special features for use in cars usually belonging to a "block train" pulled or pushed by a locomotive.

Some of the function decoders are based on loco decoders and have nearly identical board and dimensions, often similarly equipped but with different software. They are also very similar in function and configurations (CVs...) to the loco decoders they are based on. The motor controls fall away, special features for the function operations are added:

A distinctive feature of all ZIMO function decoders is the **programmable SECOND ADDRESS** (CVs #64 to #68), which can be used as an alternative address for the coach containing the function decoder and is commonly set to the same address as the loco pulling the train. If all coaches of a train are equipped with such a decoder using the same (second) address, they can all be controlled simultaneously with a single key stroke (i.e. the interior light of all coaches are turned ON/OFF with a function key of the loco address, if that is the second address). With this, the simplest form of a **virtual "train bus"** becomes reality, which will certainly play a major role in future digital train technology.

10,5 x 8 x 2,2 mm 6 Fu-Outputs

MX671 Family *Miniature-Function-Decoder; unique construction (not based on a loco decoder), therefor especially small and low price*
 With **energy storage connection (25 V, unlimited capacity;**
 low Elko-/Goldcap voltage allowed if driving voltage is low).

MX671 9 wires for power pick-up, 2 function outputs and ELKO (120 mm length); solder pads for two additional outputs.

MX671R Like MX671, but with 8-pin plug as per NEM652

MX671N Like MX671, but with **6-pin digital interface as per NEM651**, directly connected; Solder pads for two more function outputs, energy storage (Elko, Goldcap).

12 x 8.5 x 2.2 mm 6 Fu-Outputs

MX681 *Production of MX681 stopped since 2017, replaced by MX671*

20 x 11 x 3.5 mm 8 Fu-Outputs - 2 Servos - SUSI

MX685 Family *Function-Decoder, compact design for universal applications.*

MX685 7 wires (120mm long) for power pick-up, 4 function outputs. Solder pads are available for further outputs and for 2 servos or SUSI.

MX685P16 MX685 with **16-pin PluX connector** mounted on decoder board.

(MX685R) (Versions with 8-pin plug as per NEM652 on 70mm wires
(MX685F) or 6-pin plug on 70mm wires; special order only).

20.5 x 15.5 x 3,5mm 8 Fu-Outputs - 2 Servos - SUSI

MX686D High performance **Function-Decoder** with **21-pin "MTC" plug** mounted directly on decoder board and built-in **energy storage circuitry (25V)**. 9 wires for power pick up, 4 function outputs., Elko, low voltage (120 mm), Solder pads for 4 more function outputs, 2 servo outputs or SUSI.

MX686 *Production of MX686 (wired version) stopped since 2020*

28 x 15.5 x 3.5 mm 8 Fu-Outputs - 2 Servos - SUSI

MX687 *Production stopped since 2018, replaced by MX675*

22 x 15 x 3.5 mm 10 Fu-Outputs - 2 Servos - SUSI

MX673P22 *Function Decoder with PluX22 plug and energy storage circuitry (16 V)*

25 x 15 x 4 mm 12 Fu-Outputs - 2 Servos - SUSI - Low Voltage

MX675V Family *Function-Decoder, with PluX22-plug or wires, more power, and energy storage circuitry (16 V, up to 6800 µF) and Low-voltage output (adjustable 1,5 to 17 V).*

MX675V 10 wires for power pick-up, 4 function outputs., Elko, low voltage (120 mm), solder pads for 8 more function outputs and 2 Servo outputs or SUSI, low voltage output 1,5 to 17 V. (in 8 levels adjustable, either through solder bridges or CV #264)

MX675VP22 Like MX675V, with **22-pin PluX-plug** (currently only available on request)

26 x 15 x 3.5 mm 10 Fu-Outputs - 2 Servos - SUSI - Low Voltage

MX676V *Function-Decoder with 21MTC-plug, more power, and energy storage circuitry (16 V, up to 6800 µF) and low-voltage output (adjustable 1,5 to 17 V).*

15 x 9.5 x 2.8 mm 0.7 A - 8 Fu-Outputs - 2 Servos - SUSI

MX688N18 *Production stopped since 2020, replaced by MX689*

14 x 9.5 x 2.1 mm 8 Fu-Outputs (of those 4 logic levels) - 2 Servos - SUSI

MX689N18 *Function-Decoder with Next-18 plug; unique construction (not based on a loco decoder), therefor especially small and low price*



2 Technical Information

Allowable track voltage	min. 10 V
MX671, MX681	max. 35 V
MX685, MX686, MX687, MX688, MX689.....	DCC and DC-Analog operation .. max. 35 V
MX685, MX686, MX687, MX688, MX689	AC-Analog operation .. max. power pulse 50 V
Maximum continuous total current *)	
MX671, MX671R, MX671N	0.7 A
MX681, MX681N, MX681R	0.7 A
MX685, MX685R, MX685P16	1.0 A
MX688N18, MX689N18	0.7 A
MX673P22, MX686, MX686D, MX687	1.2 A
MX675V, MX675VP22, MX676VD	1,8 A
Operating temperature	- 20 to 100 °C
Dimensions (L x W x H)	
MX671, MX671R, MX571N	10.5 x 8 x 2.2 mm
MX681, MX681R, MX681N.....	12 x 8,5 x 2 mm
MX688N18.....	14 x 9,5 x 2.1 mm
MX685, MX685R, MX685P16	15 x 9,5 x 2,8 mm
MX686, MX686D.....	20 x 11 x 3.5 mm
MX673P22.....	22 x 15 x 3.5 mm
MX675V, MX675VP22	25 x 15 x 4 mm
MX676VD	26 x 15 x 3.5 mm
MX687V, MX687W, MX687WD	28 x 15.5 x 3.5 mm

*) The short circuit protection is carried out for the total current of all outputs. Use the "soft start" option (i.e. CV #125 = 52) to prevent cold-start problems of light bulbs (in-rush current interpreted as a short circuit, which leads to the output being turned off!

Software - Update:

ZIMO decoders can be updated by the user, provided that one of the following update devices is at hand: ZIMO decoder update-module **MXULF** (since 2011), system-cab **MX31ZL** or **command station MX10**. The updating process is carried out via a USB stick (MXULF, MX31ZL / MX10) or a PC with Windows operating system and the program ZIMO Firmware Flasher (within the ZIMO Sound Programmer **ZSP**).

The same hardware together with the program ZSP is also used to load sound projects into the decoder.

There is **no need to remove the decoder or to open up the locomotive**. Just set the locomotive on a track section connected to the update module and start the update with the computer or other equipment mentioned above.

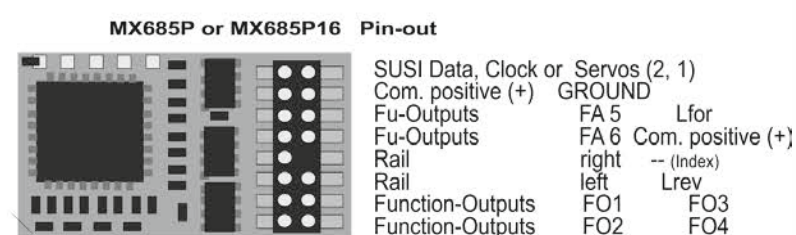
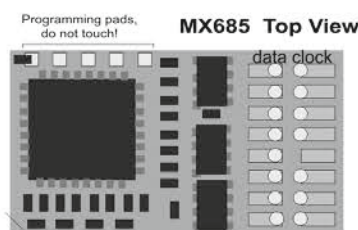
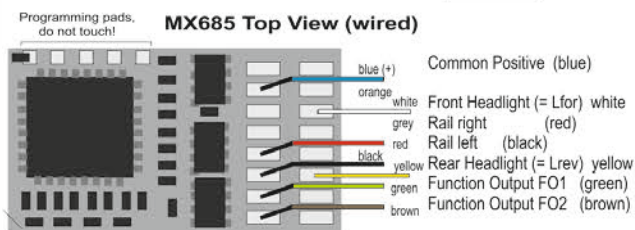
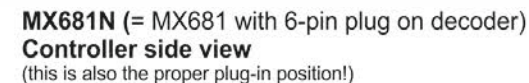
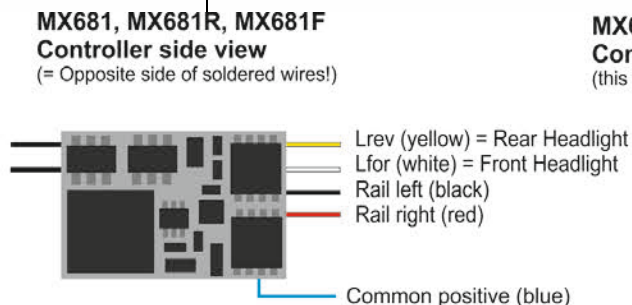
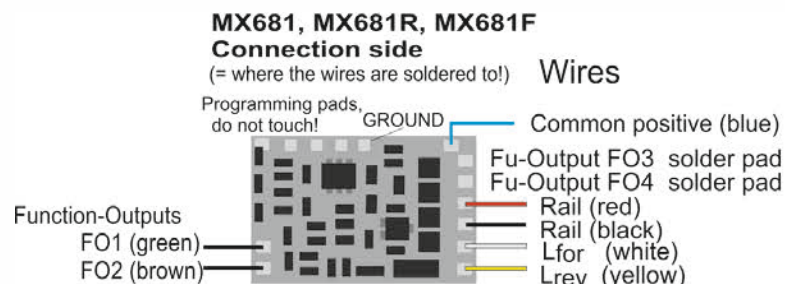
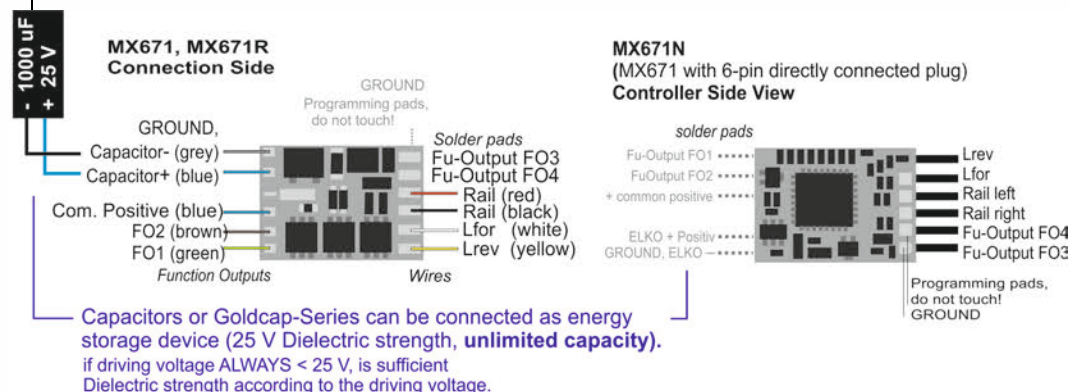

MX686 Top Side
(until 2012, based on MX631)

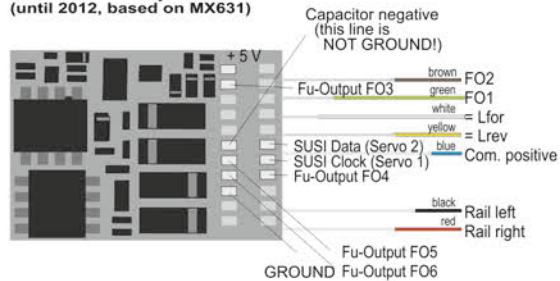

MX686D (bis 2012) Top Side View
(until 2012, based on MX631)

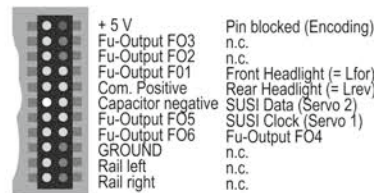

MX686, ...D Bottom Side View
(until 2012, based on MX631)

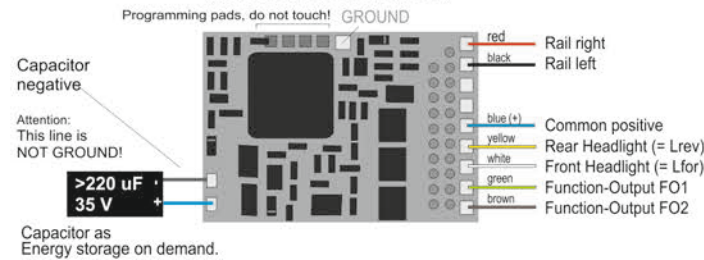

MX686 Top Side view
(since 2013, based on MX634)

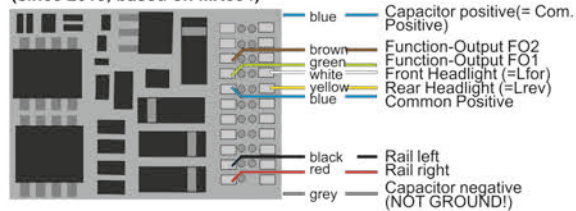

MX686D, C Top Side View
(since 2013, based on MX634)

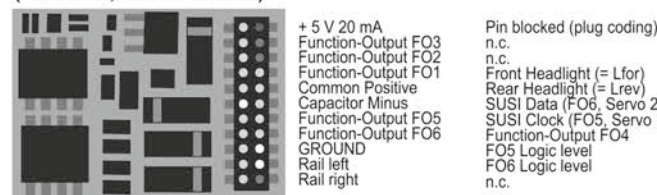

MX686 Bottom Side View
since 2013, based on MX634)

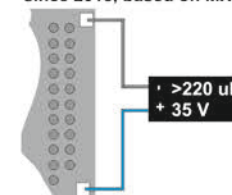

with CV # 8 = 3 > MX686D is converted to MX686C (i.e. Outputs FO3, FO4 become Logic Level Outputs)
with CV # 8 = 4 > MX686C is converted to MX686D (i.e. Outputs FO3, FO4 become „normal“ Function-Outputs)

MX687, ..V, W Oberseite

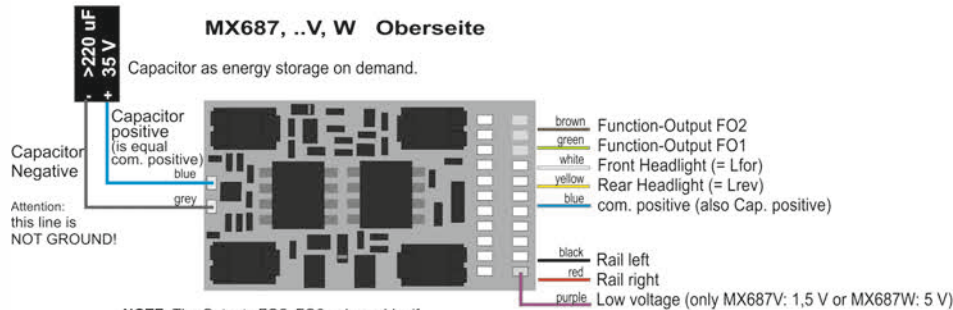

NOTE: The Outputs FO5, FO6 only usable, if SUSI is not active (see CV #124, Bit 7) and Servos are not in operation (CVs #181, #182)

MX687, ..V, W Bottom Side View

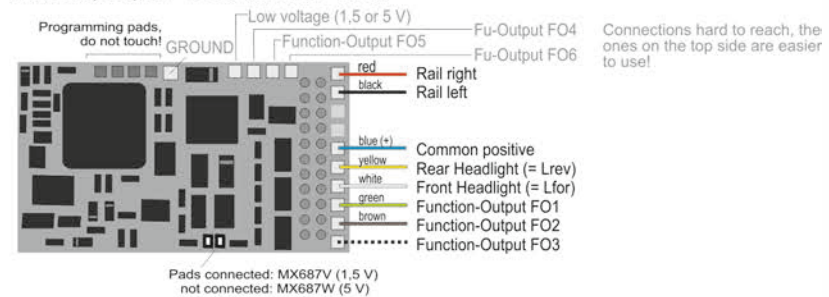

MX687D, VD, WD Top Side View

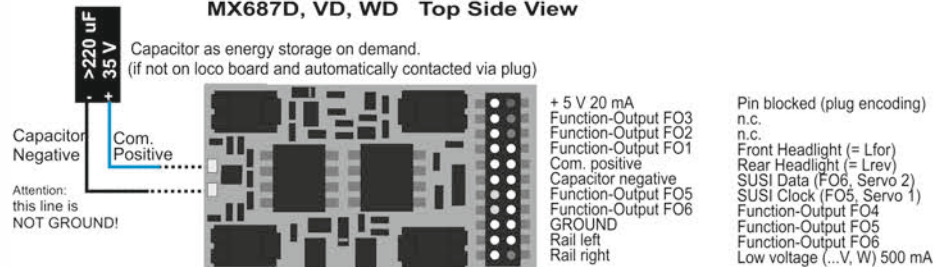

MX687D, VD, WD Bottom Side view

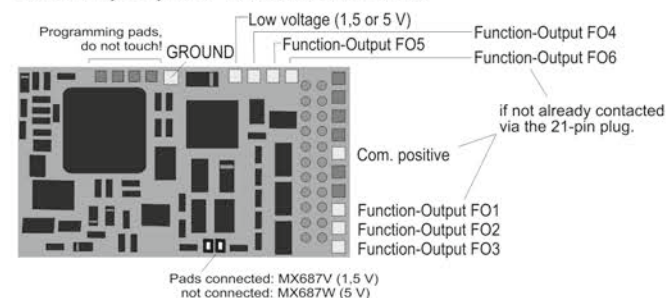

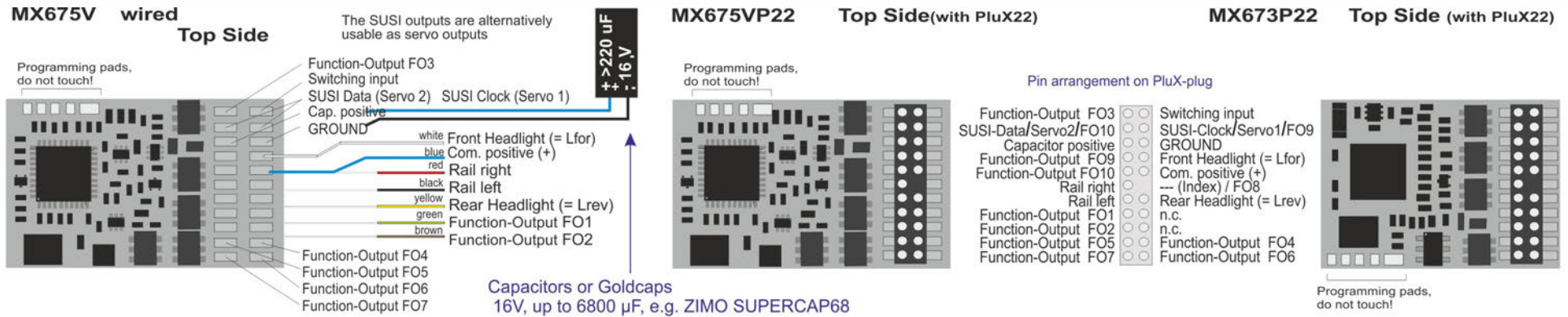

MX676VD Top Side View

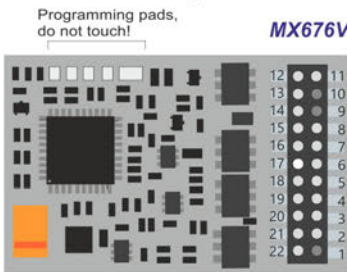

MX676VD MTC-Decoder according to ZIMO convention **switchable to MTC decoder according to Railcommunity standard**

+ 5 V 20 mA (or low voltage 500 mA on request)	12 ● 11	Indexpin (no puncture), Capacitor Plus on solder pad
Function Output F03 normal F03 Logic level	13 ● 10	n.c.
Function Output F02 (normal)	14 ● 9	n.c.
Function Output F01 (normal)	15 ● 8	Front Headlight (= Lfor)
Com. Positive (or low voltage on request)	16 ● 7	Rear Headlight (= Lrev)
Function Output F05 (Logic level)	17 ● 6	SUSI Data (FO8, Servo 2)
n.c.	18 ● 5	SUSI Clock (FO7, Servo 1)
n.c.	19 ● 4	Function Output FO4 normal
GROUND	20 ● 3	Function Output FO5 normal
Left Rail	21 ● 2	Function Output FO6 (normal)
Right Rail	22 ● 1	n.c.

F04 Logic level
F06 Logic level

The pin assignment of type MX676VD corresponds to the usual convention for ZIMO decoders (such as MX634D or Sound-Decoder MX644D) With the switchover the pin assignment corresponds to a **type C** (e.g. MX644C) and with this the Norm RCN-121 of VHDM (RailCommunity)

Conversion of the two types into each other via CV #8 possible at any time!

with CV # 8 = 3 > **MX676VD** is converted to **Typ C**, i.e. pins 13, 4 (Outputs FO3, FO4) become logic level function outputs, (Pseudo-Programming, Value does NOT remain in CV)

Pin 3 becomes output FO6 as logic level function output,
Pin 2 is not used

with CV # 8 = 4 > **MX676V** as **Typ C** becomes **MX676VD** again, i.e. Pins 13, 4 Outputs FO3, FO4) become „normal“ function outputs*), (Pseudo-Programming, Value does NOT remain in CV)

Pin 3 becomes output FO5 as „normal“ function output,
Pin 2 becomes output FO6 as „normal“ function output

*) „normal“ function output, also referred to as „amplified“ output = Suitable for direct connection of a consumer (Light, smoke generator, ...) between any positive voltage (e.g. according to the positive pole of the decoder) or low voltage and this output.
„Logic level output“ = Output accepts voltage level 0V and 5V depending on switching state (0, 1), external amplification necessary, possibly directly suitable for LED.

MX675V, ..P22, MX676VD Bottom Side

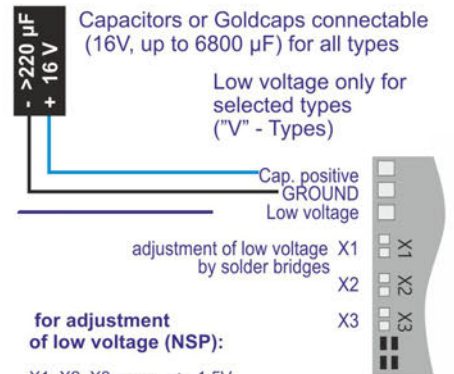

for adjustment of low voltage (NSP):

- X1, X2, X3 open => 1.5V
- X1 connected => 3V
- X2 connected => 5V
- X2, X1 connected => 6V5
- X3 connected => 12V
- X3, X1 connected => 14V
- X3, X2 closed => 16V
- X3, X2, X1 closed => 17V

Low voltage optionally also adjustable by:

- CV #264 = 0: 1.5 V
- = 1: 3 V
- = 2: 5 V
- = 3: 6.5 V
- = 4: 12 V
- = 5: 16 V
- = 6: 17 V

It is convenient and recommended to use only one of the two possibilities for setting the low voltage;

But it is also possible to combine both methods: if the value in CV #264 is read binary (for example 3 = 0000 0011) the "1" are the same as connected solder bridges (so in case of 3 like X1 and X2). The low voltage results from the OR-connection of the solder bridges (X1, X2, X3) and the bits 0, 1, 2 of CV #264. So the combination always results in a higher voltage, for example CV #264 = 3 AND solder bridge Xx results in 17V.



MX688N18
Plug side View (Next -18)

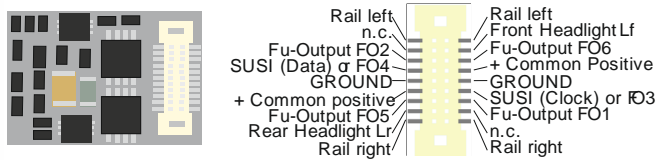

Note: FO3, FO4 as logic level output to SUSI pins, if CV #124, Bit 7 = 1

MX689N18
Plug side View (Next -18)

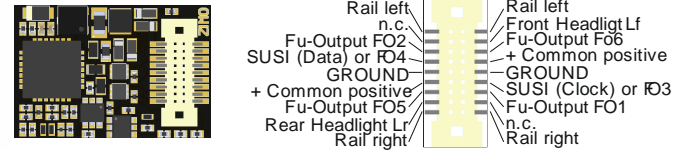

Note: FO3, FO4 as logic level output to SUSI pins, if CV #124, Bit 7 = 1

MX689N18
Bottom View (Next -18)





3 Addressing and Programming

ZIMO decoders can be programmed in

- **“Service Mode”** (on the **programming track**) for assigning a new address or reading and writing CV content but also in
- **“Operational Mode”** (a.k.a. “Programming on the main” or “PoM”), which is done on the main track; programming CVs “on the main” is always possible in operational mode. However, an acknowledgement of successful programming steps or reading out of CVs is only possible with a DCC system capable of **RailCom**.

3.1 Programming in “Service mode” (on programming track)

Before programming is actually possible, the decoder must be unlocked with

CV #144 = 0 or = 128 (the latter allows programming but prevents decoder updating).

This is normally the case but in many sound projects the programming lock is activated to prevent accidental changes. Therefore, it is useful to check that CV, especially when programming attempts have already failed.

The acknowledgments of successful programming steps on the programming track as well as CV read-outs are accomplished by power pulses, which the decoder generates by briefly engaging the motor and/or headlights. If the motor and/or headlights do not draw enough power or don't draw power at all (i.e. they are not connected), acknowledgments for successful programming or CV read-outs are not possible.

To make acknowledgments possible in such cases activate CV #112 bit 1, which enables the decoder to use an alternate acknowledgment by sending high frequency pulses from the motor end stage. Whether this method is successful though depends on the DCC system used.

CV	Denomination	Range	Default	Description
#144	Programming and Update Lock Note: The programming lock has no effect on CV #144, which is therefore always accessible for unlocking.	0, 64, 128, 192	0	= 0: programming and update lock not active Bit 6 = 1: programming the decoder in „Service Mode“ is blocked as a protection against unwanted reprogramming. Note: Programming in “Operational Mode” is not locked because any such programming only applies to the active loco address and reprogramming the wrong locomotive is therefore not possible. Bit 7 = 1: Software updates via MXDECUP, MX31ZL or other means are locked.
#112	Special ZIMO configuration bits	0 - 255	2	Bit 1 = 0: Normal acknowledgment in “Service Mode”; by activating motor and headlight outputs. = 1: High frequency pulses instead of normal acknowledgments from motor and headlights.

3.2 Programming in “Operational mode” (a.k.a. on-the-main, “PoM“)

According to the current NMRA DCC standards it is only possible to program and read CVs on the main track, but not to assign new vehicle addresses. However, certain DCC systems (among them ZIMO with the system generation MX10/MX32 and later) will allow addresses to be modified on the main track with the help of bidirectional communication.

All ZIMO decoders are equipped with bidirectional communication (“**RailCom**”) and can therefore (with a corresponding DCC system such as ZIMO MX31ZL and all devices of the new MX10/MX32 generation) read, program and acknowledge successful CV programming steps in operational mode (on the main track). This requires RailCom to be activated, which is the case if the following CVs are set as:

CV #29, Bit 3 = 1 AND CV #28 = 3

This is usually the default setting, except in certain sound projects or OEM CV sets, in which they need to be set first.

This does not apply to function decoders; they have CV #28 = 2. This is because ONLY the Loco (Loco decoders) should report back to the central station as feedback from function decoders (which are set to CV #28 = 3) that are on the same track section as the loco, overwrite the feedback from the loco decoder.

CV	Denomination	Range	Default	Description
#28	Bi-Directional Communication (“RailCom”) * Configuration	0 - 3	2	Bit 0 - RailCom Channel 1 (Broadcast) 0 = OFF 1 = ON Bit 1 - RailCom Channel 2 (Data) 0 = OFF 1 = ON
#29	Configuration Data #1	0 - 63	14 = 0000 1110 Bit 3 = 1 (“RailCom” is activated)	Bit 0 - Train direction: 0 = normal, 1 = reversed Bit 1 - Number of speed steps: 0 = 14, 1 = 28 Bit 2 - DC operation (analog): 0 = disabled 1 = enabled Bit 3 - RailCom (“bidirectional communication”) 0 = deactivated 1 = activated Bit 4 - Individual speed table: 0 = off, CV #2, 5 and 6 are active. 1 = on, according to CV ‘s # 67 – 94 Bit 5 - Decoder address: □ 0 = primary address as per CV #1 □ 1 = ext. address as per CV #17+18

* **Broadcast:** Decoder sends information without being requested

Data: Decoder sends information only upon request.



3.3 Decoder-ID, Load -Code, Decoder-Type and SW-Version

CV	Denomination	Range	Default	Description
#250, #251, #252, #253	Decoder-ID also contains a code (in CV #250) that identifies the decoder type	Read only	-	The decoder ID (serial number) is automatically entered during production: The first Byte (CV #250) denotes the decoder type; the three other Bytes contain the serial number. The decoder ID is primarily used for automatic address recognition when an engine is placed on the layout track (future function) as well as in conjunction with the "load code" for "coded" sound projects (see CV #260 - 263).
#8	Manufacturer ID and HARD RESET or ACTIVATION of special CV sets	Read only <small>For pseudo programming see "Description" column on the right.</small>	145 (= ZIMO)	Reading out this CV always result in "145" ("10010001"), the number issued for ZIMO by the NMRA. This CV is also used to reset the decoder by Pseudo-Programming. Pseudo-Programming means that the entered value is not really stored, but rather used to start a defined action. CV #8 = "8" → HARD RESET (NMRA standard); all CVs reset to the last active CV set , or the default values listed in this CV table if no such set was active. CV #8 = "9" → HARD RESET for old LGB-operation (14 speed steps, pulse chain commands). Further options: see chapter "CV Sets"!
#7	Manufacturer Version No. (SW-Version) Also see CV #65 for Sub-Version Number and special procedures for programming with "Lokmaus-2" and other "low level" systems	Read only <small>Pseudo-programm. see explanation to the right</small>	-	This CV holds the version number of the firmware currently in the decoder. With the help of "Pseudo-programming" it also helps to program decoders with DCC systems of limited range: Ones digit = 1: Subsequent programming value + 100 = 2: ... + 200 Tens digit = 1: Subsequent CV number + 100 = 2: ... + 200 etc. = 9: ... + 900 Hundreds digit = 0: Revaluation applies only once = 1: Revaluation applies until power-off
#65	SW-Sub-Version Number Also see CV #7 for Version Number	Read only	-	This CV indicates a possible sub-version number of the main version noted in CV #7. The entire SW version number is thus composed of CV #7 and #65 (i.e.: 28.15).

3.4 The (first) vehicle address

Decoders are usually programmed at delivery to **address 3 (CV #1 = 3)**, for the DCC as well as the MM (Märklin Motorola) format. All aspects of operation are possible with this address but it is recommended to change to a different address as soon as possible.

The DCC address range goes up to 10239 and therefore exceeds the range of a single CV. Addresses higher than 127 are stored in CV #17 and #18. Bit 5 in CV #29 is used to select between the short address in CV #1 and the long address in CVs #17/18.

☞ Most digital systems (with the possible exception of very old or simple products) calculate the value for the CVs involved automatically and also set Bit 5 in CV #29 to the proper value when writing the address, so that the user does not have to deal with the necessary coding.

CV	Denomination	Range	Default	Description
#1	Primary (short) Address	DCC: 1 - 127 MM: 1 - 80	3	The "short" (1-byte) loco address (DCC, MM). In the case of DCC: The address in CV #1 is only valid if CV #29, Bit 5 = 0. If CV #29 Bit 5 = 1, the long address in CV #17 + #18 is used.
#17 + #18	Extended (long) address	128 - 10239	0	The long DCC address applies to addresses >127. It is only active if CV #29 Bit 5 = 1.
#29	Configuration Data #1	0 - 63	14 = 0000 1110 with Bit 5 = 0 (for short address)	Bit 0 - Train direction: 0 = normal, 1 = reversed Bit 1 - Number of speed steps: 0 = 14, 1 = 28 Bit 2 - DC operation (analog): *) 0 = disabled 1 = enabled Bit 3 - RailCom („bidirectional communication") 0 = deactivated 1 = activated Bit 4 - Individual speed table: 0 = off, CV #2, 5 and 6 are active. 1 = on, according to CV s #67 – 94 Bit 5 - Decoder address selection (DCC): 0 = short address as per CV #1 1 = long address as per CV #17+18

Decoder-controlled consisting (a.k.a. "Advanced consisting")

Combined operation of two or more locomotives (consisting) can be organized by
- the DCC system (common practice with ZIMO systems, without changing any CVs) or
- by the following CVs, which can be programmed manually or managed by the DCC system (often the case with American systems).

This chapter covers only the latter; the decoder controlled consisting!



CV	Denomination	Range	Default	Description
#19	Consist address	0 - 127	0	A common consist address for 2 or more engines can be entered in this CV to each loco of the same consist. If CV #19 > 0: Speed and direction is governed by this consist address (not the individual address in CV #1 or #17+18); functions are controlled by either the consist or individual address, see CVs #21 + 22.
#21	Consist addr active for F1 - F8	0 - 255	0	Functions defined here will be controlled by the consist address. Bit 0 = 0: F1 controlled by individual address = 1: by consist address Bit 1 = 0: F2 controlled by individual address = 1: by consist address F3, F4, F5, F6, F7 Bit 7 = 0: F8 controlled by individual address = 1: by consist address
#22	F0 forw., backw. Consist addr active for F9-F12	0 - 63	0	Select whether headlights and/or functions F9 – F12 are controlled via consist address or individual address. Bit 0 = 0: F0 (forw.) controlled by individual address = 1: by consist address Bit 1 = 0: F0 (rev.) controlled by individual address = 1: by consist address Bit 2 = 0: F9 controlled by individual address = 1: by consist address Bit 3 = 0: F10 controlled by individual address = 1: by consist address Bit 4 = 0: F11 controlled by individual address = 1: by consist address Bit 5 = 0: F12 controlled by individual address = by consist address

3.5 The second address in a function decoder

The second address in

CV #64 (short) or CV #67+68 (long)

is used as an alternative address for cars or coaches equipped with a function decoder. The second address is usually the decoder address of a locomotive. If all coaches of a train are equipped with function decoders using the loco address as the second address, the lights of all coaches can for example be turned ON/OFF with a single loco function key.

See chapter "Function mapping".

The "virtual motor control" follows the commands of the second address, if one is defined (value > 0).

CV	Denomination	Range	Default	Description
#64	Short SECOND ADDRESS	1 - 127	0	The "short" (1-byte) second address; it is active when CV #112, Bit 5 = 0.
#67 #68	Long SECOND ADDRESS	128 - 10239	0	The "long" second address; it is active when CV #112, Bit 5 = 1. Note: In contrast to the "first long address", the cab cannot calculate the proper CV values automatically. As a work around, program the desired second address temporarily as the first address. Then read out CVs #17/18 and enter these values in CVs #67/68. Program the first address back to the original address, if used*
#112	Special ZIMO configuration bits	0, 8, 32, 40	2	Bit 1 = 0: Normal "service mode" acknowledgement. = 1: Special "high frequency" acknowledgement; because LEDs typically don't draw enough current for "service mode" acknowledgement. Bit 5 = 0: Select between "short" or = 1: "long" second address

*The calculation is explained on the last page of this instruction manual

3.6 Analog operation

All ZIMO decoders are capable of operating on conventional layouts operated with DC power packs, including PWM throttles, in **analog DC** as well as in **analog AC** (Märklin including the high voltage pulse for direction change).

To allow analog operation:

CV #29, Bit 2 = 1

For function decoders analog operation only applies to the function outputs for which there are settings within the loco decoders.

CV	Denomination	Range	Default	Description
#29	Configuration Data #1	0 - 63	14 = 0000 1110 includes Bit 2 = 1 (Analog operation enabled)	Bit 0 - Train direction: 0 = normal, 1 = reversed Bit 1 - Number of speed steps: 0 = 14, 1 = 28 Bit 2 - Automatic switchover to analog: 0 = disabled 1 = enabled Bit 3 - RailCom ("bidirectional communication") 0 = deactivated 1 = activated Bit 4 - Individual speed table: 0 = off, CV #2, 5 and 6 are active. 1 = on, according to CV s #67 - 94 Bit 5 - Decoder address: 0 = primary address as per CV #1 1 = ext. address as per CV #17+18



CV	Denomination	Range	Default	Description
#13	Alternate Mode Function Status F1- F8	0 - 255	0	Select the functions that should be ON during analog operation. Bit 0 = 0: F1 OFF in analog mode = 1: ...ON... Bit 1 = 0: F2 OFF in analog mode = 1: ...ON... F3, F4, F5, F6, F7 Bit 7 = 0: F8 OFF in analog mode = 1: ...ON...
#14	Alternate Mode Function Status F0, F9-F12 and acceleration, deceleration and motor control in analog	0 - 255	67, that is Bit 0, 1, 6 = 1	Select the functions that should be ON during analog operation. Bit 0 = 0: F0 (forward) OFF in analog mode = 1: ...ON... Bit 1 = 0: F0 (reverse) OFF in analog mode = 1: ...ON... Bit 2 = 0: F9 OFF in analog mode = 1: ...ON... F10, F11 Bit 5 = 0: F12 OFF in analog mode = 1: ...ON... Bit 6 = 0: Analog operation with momentum as per CVs #3 + 4; often needed for sound = 1: Analog operation without momentum from CVs #3 + 4; immediate response to track voltage similar to classic analog control. Bit 7 = 0: Analog operation without motor regulation. = 1: Analog operation with motor regulation.

CV	Denomination	Range	Default	Description
#2	Vstart with 3-step curve	1 - 255	1	Internal speed step (1 ... 255) applied as lowest external speed step (= speed step 1) (applies to 14, 28, or 128 speed step modes) = 1: lowest possible speed
#5	Vhigh with 3-step curve	0 - 255	1 or 255	Internal speed step (1 ... 255) applied as highest external speed step (14, 28 or 128, depending on the speed step mode selected in CV # 29, Bit 1) = 1 (same as 255): fastest speed possible.
#6	Vmid	1, ¼ to ½ of the value in CV #5	1 (= @ 1/3 of top speed)	Internal speed step (1 ... 255) applied as medium external speed step (that is, speed step 7, 14 or 63 depending on the speed step mode selected in CV #29, Bit 1) "1" = default curve (Medium speed is set to one third of top speed, i.e., if CV #5 = 255 the curve is the same as if CV #6 would be programmed to 85) The speed curve resulting from CV #2, #5 and #6 is automatically smoothed out to prevent kinks.
#3	Acceleration rate	0 - 255	2	The value multiplied by 0.9 equals acceleration time in seconds from stop to full speed. The effective default value for sound decoders is usually not the value given here, but is determined by the loaded sound project.
#4	Deceleration rate	0 - 255	1	The value multiplied by 0.9 equals deceleration time in seconds from full speed to a complete stop. The effective default value for sound decoders is usually not the value given here, but is determined by the loaded sound project.
#23	Acceleration Adjustment	0 - 255	0	To temporarily increases the acceleration rate to a new load or when used in a consist. Bit 0-6: entered value increases or decreases acceleration time in CV #3. Bit 7 = 0: adds above value to CV #3. = 1: subtracts above value from CV #3.
#24	Deceleration Adjustment	0 - 255	0	As above, but for deceleration and therefore CV #4.
#121	Exponential Acceleration	0 - 99	0	Acceleration time (momentum) can be stretched in the lower speed range: Tens digit: Percentage of speed range to be included (0 to 90%). Ones digit: Exponential curve (0 to 9). EXAMPLE: CV #121 = 11, 23 or 25 are typical initial test values.
#122	Exponential Deceleration	0 - 99	0	Deceleration time (momentum) can be stretched in the lower speed range: Tens digit: Percentage of speed range to be included (0 to 90%).

3.7 "Virtual" motor control and momentum

Even though function decoders don't have an actual motor output, they can still be programmed with parameters for "virtual motor control", in order to synchronize the actions of the function decoder with the loco decoder, provided the first or second address of the function decoder is identical with the loco decoders. This is especially important during acceleration or deceleration, for example, when activating the direction key without first stopping the train. It makes sense to use the same settings in these CVs as are used in the locomotive decoder.

However, the 28-speed point curve is not available, only the three-point curve, because the relevant CV numbers are used for the second address. For this reason, Bit 4 in CV #29 is also not available. And of course, CV settings that relate to motor feedback are unnecessary.

For many applications though, the motor control CVs are not important in function decoders. Setting CV #3 and #4 to match the CVs of the loco decoder is sufficient.



CV	Denomination	Range	Default	Description
				Ones digit: Exponential curve (0 to 9). <u>EXAMPLE:</u> CV #122 = 11, 23 or 25 are typical initial test values.
#49	Signal controlled (HLU) acceleration	0 - 255	0	Entered value multiplied by 0.4 equals acceleration time in seconds from stop to full speed when: "ZIMO signal controlled speed influence" with ZIMO MX9 track section module, StEin or successor or "asymmetrical DCC signal" method (Lenz ABC) is employed
#50	Signal controlled (HLU) deceleration	0 - 255	0	Entered value multiplied by 0.4 equals deceleration time in seconds from full speed to complete stop when: "ZIMO signal controlled speed influence" with ZIMO MX9 track section module, StEin or successor or "asymmetrical DCC signal" method (Lenz ABC) is employed
#51 #52 #53 #54 #55	Signal controlled (HLU) speed limits #52 for "U", #54 for "L", #51, 53, 55 for intermediate steps	0 - 255	20 (HU) 40 (U) 70 (UL) 110 (L) 180 (LF)	ZIMO "signal controlled speed influence" method (HLU) using MX9, StEin or successor: Defines the internal speed steps for each of the 5 speed limits generated via HLU.
#59	Signal controlled (HLU) delay	0 - 255	5	ZIMO signal controlled speed influence (HLU) with ZIMO MX9 track section module, StEin or future module or when using the "asymmetrical DCC signal" stopping method (Lenz ABC): Time in tenths of a second until the locomotive starts to accelerate after receiving a higher signal controlled speed limit command.
#27	Decoder Automatic Stopping Configuration (Lenz "ABC" method)	0, 1, 2, 3	0	Bit 0 = 1: Stops are initiated if voltage in right rail is higher than in left rail (in direction of travel). This setting, CV #27 = 1, IS THE COMMON APPLICATION for this feature (provided the decoder is wired correctly to the rail). Bit 1 = 1: Stops are initiated if voltage in left rail is higher than in right rail (in direction of travel). Stopping is directional if only one of the two bits is set (not both). Traveling in the opposite direction will have no effect. Use the other bits in case the train stops in the wrong direction! Bit 0 and Bit 1 = 1 (CV #27 = 3): Stops in both directions, regardless of rail polarity.

CV	Denomination	Range	Default	Description
#134	Asymmetrical threshold for stopping with asymmetrical DCC signal (Lenz ABC method).	1 - 14, 101 - 114, 201 - 214 = 0,1 - 1,4 V	106	Hundreds digit: Sensitivity adjustment, changes the speed with which the asymmetry is being recognized. = 0: fast recognition (but higher risk of errors, i.e. unreliable stopping). = 1: normal recognition (@ 0.5 sec.), pretty save results (default). = 2: slow recognition (@ 1 sec.), very reliable.
#29, #124, #112	Individual bits in these CVs are responsible for the correct reaction to "DC" and "Märklin" brake sections.	-	-	Set the following CVs for polarity dependent DC brake sections: CV #29, Bit 2 = 0 and CV #124, Bit 5 = 1. For polarity independent brake sections (" Märklin-Brake sections ") set CV #29, Bit 2 = 0 and CV #124, Bit 5 = 1 and additionally CV #112, Bit 6 = 1.
#124	Shunting key functions: Low gear (half speed) and Momentum reduction or deactivation NOTE: Extended shunting key selection in CVs #155, 156	Bits 0 - 4, 6	0	Select a function key for LOW GEAR ACTIVATION: Bit 4 = 1 (and Bit 3 = 0): F3 as half-speed key Bit 3 = 1 (and Bit 4 = 0): F7 as half-speed key Select a function key for MOMENTUM DEACTIVATION: Bit 2 = 0 (and Bit 6 = 0): "MN" key for deactivation, Bit 2 = 1 (and Bit 6 = 0): F4 key for deactivation Bit 6 = 1 (Bit 2 is irrelevant): F3 for deactivation. Effect of above key (MN, F3 or F4) on MOMENTUM: Bit 1, 0 = 00: no effect on momentum □ = 01: removes momentum of CV #121 + #122 = 10: CV #3 + #4 reduced to ¼. = 11: removes all momentum above.
#155	Selecting a function key as half-speed key	0 - 19	0	Expanding on the settings of CV #124, if another key is required than F3 or F7. Consult the loco decoder manual for more information.
#156	Selecting a function key for deactivating momentum	0 - 19	0	Expanding on the settings of CV #124, if another key than F3, F4 or MAN is required for momentum deactivation. Consult the loco decoder manual for more information.
#157	Selecting a function key for the MAN function Only for non-ZIMO systems, which don't have the MN key.	0 - 19	0	The MAN function (or MAN key on ZIMO cabs) was originally designed for ZIMO applications only, in order to cancel stop and speed limit commands applied by the signal controlled speed influence system (HLU). This function was expanded in later software versions to include "asymmetrical DCC signal stops" (Lenz ABC). If ZIMO decoders are used with non-ZIMO systems, a function key can now be assigned with CV #157 to cancel a signal controlled speed limit or stop command.



3.8 The NMRA-DCC function mapping

CVs #33 to #46 are reserved for the function mapping of the **first address**. It links a specific function key to a specific function output. It is also possible to control several function outputs with one function key. Each function key is represented by a single CV in the in the table below. The individual bits of a CV represent individual function outputs.

Due to the fact that function decoders have a maximum of 8 function outputs (headlights, FA1-FA6), the "superfluous" bits (see table below) are shifted to the left (according to NMRA rules), so that "low" function outputs (FA0v / r, FA1) can also be controlled by "high" function keys (F3 and higher).

Below: NMRA standard bits (dark gray boxes) and "right shifted" bits (shaded gray):

NMRA Function	CV	Number key on ZIMO cabs	Function outputs;							
			FA6	FA5	FA4	FA3	FA2	FA1	Rear light	Front light
F0	#33	1 (L) fw	7	6	5	4	3	2	1	0●
F0	#34	1 (L) re	7	6	5	4	3	2	1●	0
F1	#35	2	7	6	5	4	3	2●	1	0
F2	#36	3	7	6	5	4	3●	2	1	0
F3	#37	4	4	3	2	1●	0	7	6	5
F4	#38	5	4	3	●	1	0	7	6	5
F5	#39	6	4	3●	2	1	0	7	6	5
F6	#40	7	4●	3	2	1	0	7	6	5
F7	#41	8	1	0	7	6	5	4	3	2
F8	#42	9	1	0	7	6	5	4	3	2
F9	#43	0	1	0	7	6	5	4	3	2
F10	#44	↑1	1	0	7	6	5	4	3	2
F11	#45	↑2	1	0	7	6	5	4	3	2
F12	#46	↑3	1	0	7	6	5	4	3	2

The black dots in the table above indicate the **default settings** at the time of delivery, where each function key corresponds to the same numbered function output. Therefore, the following values were written to these CVs by default:

- CV #33 = 1
- CV #34 = 2
- CV #35 = 4
- CV #36 = 8
- CV #37 = 2
- CV #38 = 4
- CV #39 = 8
- CV #40 = 16
- and so on

The **Function mapping for the Second address** is defined (in the same way as for the first address) with

CVs #69 to #82

The commands of the first and the second address are read separately, and stored according to the respective "function mapping" and the desired function output states.

After power-on (system boot-up, longer track power interruption etc.), the decoder is first waiting for a SECOND ADDRESS command (provided the second address is not 0) and the outputs are set based on this secondary address command. (First-address commands are executed only if changes in the function output states between successive first-address commands occur.) During continued operation the **"principle of the most recent change"** between first and second address commands applies.

Identical to the first address: NMRA standard bits (dark gray) and "right shifted" bits (shaded gray):

NMRA Function	CV	Number key on ZIMO cabs	Function outputs;							
			FA6	FA5	FA4	FA3	FA2	FA1	Rear light	Front light
F0	#69	1 (L) fw	7	6	5	4	3	2	1	0●
F0	#70	1 (L) re	7	6	5	4	3	2	1●	0
F1	#71	2	7	6	5	4	3	2●	1	0
F2	#72	3	7	6	5	4	3●	2	1	0
F3	#73	4	4	3	2	1●	0	7	6	5
F4	#74	5	4	3	●	1	0	7	6	5
F5	#75	6	4	3●	2	1	0	7	6	5
F6	#76	7	4●	3	2	1	0	7	6	5
F7	#77	8	1	0	7	6	5	4	3	2
F8	#78	9	1	0	7	6	5	4	3	2
F9	#79	0	1	0	7	6	5	4	3	2
F10	#80	↑1	1	0	7	6	5	4	3	2
F11	#81	↑2	1	0	7	6	5	4	3	2
F12	#82	↑3	1	0	7	6	5	4	3	2

Tip: Directional taillights with the help of special effect CVs:

With the NMRA function mapping only F0 can be directional and was intended for the headlights, so they automatically switch between "front" and "rear" when the driving direction is changed. All other functions are controlled direction-independent.

The special effect CVs #125 - 132, #159 and #160 (see chapter "Special function output effects"), each assigned to a function output (up to FO8), make it possible to have more direction dependent functions. To utilize only the directional capabilities of these CVs use only the directional Bits 0 and/or 1 without setting the actual effect-bits.



Example 1: A couple of **red taillights** are connected to function outputs FO1 and FO2 (front and rear). Both are to be actuated with F1 but should also change direction-dependently. This requires the following CV settings:

CV #35 = 12 (Bit 2 for FO1 and Bit 3 for FO2), as well as
CV #127 = 1 (for FO1) and CV #128 = 2 (for FO2).

therefor FO1 is only activated in forward direction and FO2 only in reverse, and only if the function is turned ON with the function key F1.

Example 2: Contrary to example 1 where the red taillights were switched independently from the white headlights, in this example the headlights and taillights are switched ON/OFF together at the proper end of the locomotive with F0 or F1 (depending on which end the loco is coupled to the train).

This can be done as follows:

- Connect: White front headlights to function output "front headlights"
- Red front taillights to function output FO2
- White rear headlights to function output FO1
- Red rear taillights to function output "rear headlights".

CV #33 = 1 and CV #34 = 8 front white headlights on F0forw and front red taillights on F0rev
CV #35 = 6 both white headlights as well as red taillights in the rear on F1
CV #126 = 1 / CV #127 = 2 (Direction dependence for rear white and red lights by means of "Special Effects" CV).

Alternative method: CVs #107, #108 for "One-sided light suppression", see below!

3.9 "Unilateral Light Suppression"

This is another feature, asked for by many users, that makes it possible to switch off all lighting on one side of a locomotive per one function key (usually on the "train side", i.e. where cars are coupled to the locomotive).

CV	Denomination	Range	Default	Description
#107	Light suppression (i.e. front headlights AND additionally defined function output) at cab side 1 (front)	0 - 255	0	The value of this CV is calculated as follows: The number of a function output (FO1...FO28) x 32 + number of a function key (F1, F2...F28) = Value of CV #107 Function Key: That key (F1...F28) which should turn off ALL lights on the cab side 1 (front side) AND Function Output: i.e. taillights on the same side.
#108	Cab side 2 (rear)	0 - 255	0	Same as CV #107 but for other locomotive side.
#109	additional FO side 1	1 ... 6	0	FO is set in combination with CV#107
#110	additional FO side 2	1 ... 6	0	FO is set in combination with CV#108

3.10 The "Swiss Mapping" (SW version 32 and later)

The "Swiss mapping" is a function mapping that allows the loco lighting to be used as required by Swiss prototypical locomotives, which of course is also useful for locos of other countries.

The purpose of the "Swiss mapping" is to switch various states of the locomotive lighting with different function keys, i.e. for situations like driving a single locomotive, cars coupled on driver's cab 1, or at the driver's cab 2, push-pull, shunting, etc.

Using this relatively complex method is of course only expedient if the vehicle is equipped with many independently connected lights (or LED's) and the decoder offers as many function outputs (it should at least be 6). ZIMO decoders indeed offer between 6 and 10 function outputs (with the exception of a few miniature decoders), large-scale decoders even more.

The desired lighting states are defined by **a total of 17 CV groups, each group containing 6 CVs** (CV #430 - #477). The principle is simple in itself, in that the first CV of each group contains the number (1 to 28) for a function key F1 .. F28, and the other CVs define which function outputs are to be switched on when pressing this key, each dependent on the direction of travel.

CV	Denomination	Range	Default	Description
#430	Swiss Mapping Group 1 "F-Key"	0 - 28, 29 (for F0), 129 - 157	0	The key defined here shall turn on the function outputs listed under A1 (forward or reverse) and A2 (forward or reverse). 1 - 28 for function keys F1 - F28, F29 is for F0. Bit 7 = 1: Inverts the F-key function. Bit 6 = Swiss Mapping group applies to secondary address.
#431	Swiss Mapping Group 1 "M-Key" or Special high-beam setting	Bit 0 - 6: 0 - 28, 29 (for F0) and Bit 7 or 255	0	The "normal function mapping" (according to CVs #33-#46) for the "M-key" defined here will be deactivated (that is the assigned outputs) when the "F-key" is switched on. Bit 7 = 1: the outputs listed under A1 and A2 should only switch ON if the F and M key are ON. Bit 6 = 1: The M-key outputs shall not be turned OFF if the F-key is ON and driving forward. Bit 5 = 1: The M-key outputs shall not be turned OFF if the F-key is ON and driving backwards. (from SW Ver. 35 = 157: is an often used value for this CV, because F0 (= 29) is usually selected as the "M-key" with Bit 7 = 1. F0 then acts as a general ON/OFF key. = 255 (Special high-beam setting!): the Fu-Outputs defined in the following four CVs are switched to full intensity, provided that they are controlled via the "normal function mapping", and dimmed with CV #60; this function is used, for example, to switch the headlights of a Swiss locomotive to high-beam, without switching the white taillight to high-beam. Depending on CV #399 setting: High beam is only switched on if the speed is higher than the value given



				in this CV.
#432	Swiss Mapping Group 1 "A1" forward	Bits 0 - 3: 1 - 12 14 (FO0f) 15 (FO0r) Bits 5 - 7: 0 - 7	0	Bits 0 - 3: Function output to be switched ON in forward direction provided that <u>both</u> the "F" and "M" keys are ON (if Bit 7 for the "M" key of this group is 1, otherwise "F" key ON is sufficient). Bits 7, 6, 5 (7 possible values or zero): Number of the applicable dimming CV. For example: Bit 5 = 1 means dimming according to CV #508 etc.
#433	Swiss Mapping Group 1 "A2" forward	Bits 0 - 3: 1 - 12 14 (FO0f) 15 (FO0r) Bits 5 - 7: 0 - 7	0	Bits 0 - 3: Additional function output to be switched ON in forward direction provided that <u>both</u> the "F" and "M" keys are ON (if Bit 7 for the "M" key of this group is 1, otherwise "F" key ON is sufficient). Bits 7, 6, 5 (7 possible values or zero): Number of the applicable dimming CV. For example: Bit 5 = 1 means dimming according to CV #508 etc.
#434	Swiss Mapping Group 1 "A1" reverse	As above	0	As above but for reverse direction
#435	Swiss Mapping Group 1 "A2" reverse	As above	0	As above but for reverse direction
#436 - 441	... Group 2	...	0	All 6 CVs of Group 2 are defined the same way as the 6 CVs in group 1.
#442 - 447	... Group 3	...	0	All 6 CVs of the following groups are defined the same way as the 6 CVs in group 1.
#448 - 477	... Group 4 to 8	...	0	...
#508 #509 #510 #511 #512	Dimming values for "Swiss Mapping"	(0- 31)*8 (only Bits 7 - 3 are used)	0	Each group CV (i.e. #432, 433, 434, 435) can be linked to one of these five dimming CVs. The value to enter is the dimming value (0 - 31) times the function output number. (i.e. dimming value = 16 for function output 6: 16 x 6 = 96 is the value to enter). This will dim the relevant function outputs accordingly. Only with function outputs FO0 to FO8.

3.11 Dimming, Low beam and Direction Bits

Some elements connected to function outputs often are not designed to operate with full track power, as is the case with 18V bulbs at 24V track voltage (quite common on large scale model railroads). Other times the brightness needs to be reduced simply because the light is too bright.

The best solution in such cases is to connect the positive pole of such devices to the low voltage supply of the decoder (see chapter "Technical Information"). Such low-voltage outputs are fully stabilized and the voltage will not fluctuate with changes in track voltage.

Alternatively, or in addition to this (the dimming effect is not limited to devices connected to full track power but also works with low voltage), the PWM (pulse width modulation) voltage reduction is also available with

CV #60,

which defines the PWM duty cycle. Of course, this kind of voltage reduction is also interesting because it is easy to change at any time.

NOTE: Bulbs with voltage ratings as low as 12V can be dimmed with this PWM dimming function without damage even if track voltages are considerably higher; but **not** bulbs rated below that such as 5V or 1.2V bulbs. These must be connected to one of the decoder's low voltage supply pins instead of a normal positive pin (see chapter "Installation and Wiring").

LEDs, on the other hand, require a series resistor; if however, the resistor is designed to operate at 5V, the PWM dimming is also sufficient at a track voltage of 25V (in this case the setting would be CV #60 = 50, so a reduction by one fifth).

CV #60 generally affects all function outputs. The dimming function can be restricted to specific function outputs using the following dim mask CVs.

CV	Denomination	Range	Default	Description
#60	Reduced function output voltage (Dimming). Affects all function outputs.	0 - 255	0	Reduction of function output voltage with PWM (pulse-width modulation). Useful for example for headlight dimming. <u>Example values:</u> CV #60 = 0 or 255: full voltage CV #60 = 170: 2/3 of full voltage. CV #60 = 204: 80% of full voltage.
#114	Dim Mask 1 = Excludes certain function outputs from dimming per CV #60. For higher function outputs go to CV #152.	Bits 0 - 7	0	Enter function outputs that are not to be dimmed as per CV #60. These outputs will use the full voltage available from the decoder's positive pin. Bit 0 - front headlight, Bit 1 - rear headlight, Bit 2 - function output FO1, Bit 3 - FO2, Bit 4 - function output FO3, Bit 5 - FO4 Bit 6 - function output FO5, Bit 7 - FO6 Bit value = 0: Output will be dimmed to the value defined in CV #60. Bit value = 1: Output will not be dimmed.
#152	Dim Mask 2 Continuation of CV #114	Bits 0 - 5		... Continuation of CV #114. Bit 0 - function output FO7, Bit 1 - function output FO8, Bit 2 - function output FO9,



	and FO3, FO4 as direction bit mapping	and Bit 6, Bit 7	0 0	Bit 3 - function output FO10, Bit 4 - function output FO11, Bit 5 - function output FO12. Bit 6 = 0: „normal“ = 1: "Direction bit" at FO3 and FO4 that is, FO3 is switched on when driving in reverse, FO4 is switched on when driving forward (normal mapping of FO3 and FO4 is invalid when this Bit is set).
--	---	------------------------	------------	---

Low/high beam with the help of the low beam mask

One of the two function keys F6 (CV #119) or F7 (CV #120) can be defined as a low beam key. Specific function outputs can be dimmed when the output turned ON or OFF (inverted action with Bit 7).

CV	Denomination	Range	Default	Description
#119	Low beam mask for F6 - Output assignment for (example) low/high beam headlights ATTENTION: Certain settings in CV #154 (Special output configurations) change the meaning of CVs #119 and #120 and therefore will no longer work as a low-beam mask.	Bits 0 - 7	0	Selected function outputs will dim with F6 key, according to the dim value in CV #60. Typical application: Low/high beam Bit 0 - front headlight, Bit 1 - rear headlight, Bit 2 - function output FO1, Bit 3 - function output FO2, Bit 4 - function output FO3, Bit 5 - function output FO4. Bit value = 0: Output will not be dimmed, Bit value = 1: Output will be dimmed with F6 to value defined in CV #60. Bit 7 = 0: normal action of F6. = 1: inverted action of F6. <u>EXAMPLE:</u> CV #119 = 131: Function key F6 toggles headlights between low and high beam.
#120	Low beam mask for F7	Bits 0 - 7		Same as CV #119 but with F7 as low beam key.

A "second dim value" with the help of the uncoupler- CV

If more function outputs need to be dimmed than CV #60 allows or if some function outputs require a different voltage and the uncoupler function is not needed on the same vehicle then

CV #115

can be used for an alternative low voltage supply. The respective function outputs must be defined as "uncoupler output" in the corresponding

CVs #127...#132, #159 and #160
(see "Special effects for function outputs).

CV	Denomination	Range	Default	Description
#115	Uncoupler control or Second dim value	0 - 9	0	Only active as uncoupler if "uncoupler" function is selected (value 48) in CV #127 ...132, 159 or 160: Tens digit = 0: used for dimming. Ones digit (0 to 9): PWM - volt. reduction (0 to 90%)
#127 - #132 #159 #160	Effects on FO1, FO2, FO3, FO4, FO5, FO6 on FO7, on FO8		0 0	= 48 if used as dim value #127 → FO1 #128 → FO2 #129 → FO3 #130 → FO4 #131 → FO5 #132 → FO6 #159 → FO7 #160 → FO8

3.12 The Flasher Effect

Flashing is actually a lighting effect just like all the others that are summarized in the CVs starting with #125; but for historical reasons are listed in their own CVs #117 and #118.

CV	Denomination	Range	Default	Description
#117	Flasher functions Outputs are assigned in CV #118.	0 - 99	0	Duty cycle for flasher function: Tens digit = OFF time / Ones digit = ON time (0 = 100msec, 1 = 200msec.....9 = 1 sec) <u>Example:</u> CV #117 = 55: Flashes evenly at 1 a second interval.
#118	Flashing mask - Defines which outputs operate as flashers as programmed in CV #117	Bits 0 - 7	0	Selected function outputs will flash when turned ON. Bit 0 - front headlights Bit 1 - rear headlights Bit 2 - function output FO1, Bit 3 - ...FO2 Bit 4 - ...FO3, Bit 5 - function output FO4. Bit value = 0: No flasher Bit value = 1: Output flashes when turned ON. Bit 6 = 1: FO2 flashes inverse! Bit 7 = 1: FO4 flashes inverse! (for alternate flashing, i.e. wig-wag) <u>EXAMPLE:</u> CV #118 = 12: FO1 and FO2 are defined as flashers. CV #118 = 168: Alternate flashing of FO2 and FO4

3.13 F1- Pulse Chains (Only for old LGB products)

#112	Special ZIMO configuration Bits	0 - 255	2	Bit 3 = 0: 12-Function mode = 1: 8-Function mode Bit 4 = 0: Pulse chain recognition OFF = 1: P Pulse chain recogn. ON (with old LGB sys.) Bit 7 = 0: no pulse chain generation = 1: Generates p. c. comm. for LGB sound modules
------	------------------------------------	---------	---	--



3.14 Special Effects for Function Outputs

(US and other lighting effects, Smoke generator, Uncoupler...)

Special effects can be assigned to a total of 10 function outputs with

CVs #125, #126, #127 ... #132, #159, #160
for F0fr., F0rear, FO1 FO6 , FO7 , FO8

The values for these special effect CVs contain the

actual 6-Bit – special effects code and the 2-Bit directions code

Bits 1,0 = 00: bidirectional (active in both directions)
= 01: active in forward direction only (+ 1)
= 10: active in reverse direction only (+ 2)

- Bits 7 ... 2 = 000000xx No effect, except for direction = **(0), 1, 2** (bidirectional, forward, reverse)
- = 000001xx Mars light + direction = **4, 5, 6** (bidirectional, forward, reverse)
- = 000010xx Random flicker + direction = **8, 9, 10** (ditto, ditto, ditto)
- = 000011xx Flashing headlight + direction = **12, 13, 14** ...
- = 000100xx Single pulse strobe + direction = **16, 17, 18**
- = 000101xx Double pulse strobe + direction = **20, 21, 22**
- = 000110xx Rotary beacon + direction = **24, 25, 26**
- = 000111xx Gyalrite + direction = **28, 29, 30**
- = 001000xx Ditch light type 1, right + direction = **32, 33, 34**
- = 001001xx Ditch light type 1, left + direction = **36, 37, 38**
- = 001010xx Ditch light type 2, right + direction = **40, 41, 42**
- = 001011xx Ditch light type 2, left. + direction = **44, 45, 46**
- = 001100xx Uncoupler as defined in CV #115 automatic disengagement in CV #116 = **48, 49, 50**
- = 001101xx "Soft start" = slow power-up of function output = **52, 53, 54**
- = 001110xx Automatic stoplights for street cars, stoplight-off delay, see CV #63 = **56, 57, 58**
- = 001111xx Function output turns itself off at speed >0 (i.e. turns off cab light when driving). = **60, 61, 62**
- = 010000xx Function output turns itself off after 5 minutes (i.e. to protect smoke generators form overheating). = **64, 65, 66**
- = 010001xx As above, but after 10 minutes = **68, 69, 70**
- = 010010xx Speed or load dependent **smoke generation** for **steam engines** as per CVs 137 – 139 (i.e. pre-heating at standstill, heavy smoke at high speed or high load). Smoke turns itself off as per CV #353; = **72, 73, 74**
- = 010011xx Protection circuit for servos by means of a relay that is switched OFF, if the voltage supply for generating the control signals is too low. = **76**
- = 010100xx Driving state-dependent **smoke generation** for **diesel engines** as per CVs #137 – 139 (i.e. pre-heating at standstill, heavy smoke during motor start-up sound and acceleration). = **80, 81, 82**
- = 010110xx Slow dimming up & slow dimming down of a function output; useful for various lighting effects or motor-driven devices. Setting of (From SW vers. 33.10 for sound decoders) dimming up and down time in CVs #190, #191. (From SW vers. 32.1 for non-sound decoders) = **88, 89, 90**
- = 010111xx Neon tube effect (from SW version 36.7) = **92, 93, 94**
- = 011000xx Brake sparks when braking hard (from SW version 37.0) = **96, 97, 98**

The effect CVs are also suitable **without effect** (i.e. effect code 000000) for making **function outputs direction-dependent**.

EXAMPLE: CV #127 = 1, CV #128 = 2, CV #35 = 12 (FA1, FA2 direction-dependent, switch by key F1).

CV	Denomination	Range	Default	Description
#125 ¹	Special effects American lighting effects as well as others such as uncoupler, smoke generator and more on function output F0 (front headlight) Effects can be further adjusted and modified with CVs #62 - #63 and CV #115, #116 (for uncoupler).		0	Bits 1, 0 = 00: bidirectional (active in both directions) = 01: only active in forward direction = 10: only active in reverse direction ATTENTION in case of CV #125 and #126: change CVs #33, #34.... if direction is wrong! Bits 7, 6, 5, 4, 3, 2 = effect-code EXAMPLES You want : Program CV #125 to: Mars light forward only - 00000101 = 5 Gyalrite independent of direction - 00011100 = 28 Ditch type 1 left, only forward - 00100101 = 37 Uncoupler - 00110000 = 48 Soft start of output - 00110100 = 52 Automatic stop light - 00111000 = 56 Automatic cab light OFF - 00111100 = 60 Auto. smoke OFF after 5 min – 01000000 = 64 Auto. smoke OFF after 10 min – 01000100 = 68 Speed/load depen. smoke - 01001000 = 72 Speed/load depen. diesel smoke - 01010000 = 80
#126	Special effects for rear headlight (default F0 reverse)		0	See CV #125 for details.
#127 - #132	Special effects for FO1, FO2, FO3, FO4, FO5, FO6		0	See CV #125 for details #127 → FO1 #128 → FO2 #129 → FO3 #130 → FO4 #131 → FO5 #132 → FO6
#159, #160	Special effects for FO7, FO8		0	See CV #125 for details #159 → FO7 #160 → FO8
#83	Effects modifications	0 - 9	0	Change of minimum dimming value
#63	Light effects modifications or Stop light OFF delay	0 - 99 0 - 255	51	Tens digit: sets cycle time (0 - 9, default 5), or start-up time during soft start with 001101 (0 - 0,9s) Ones digit: OFF delay time (range: 0 – 25 sec.). For stop light OFF delay (001110xx in CV #125, 126 or 127): Time in tenths of a second the stop lights remain ON after the street car comes to a full stop.
#353	Automatic smoke generator shut-down	0 - 252 = 0 - 106 min	0	For special effect codes "010010xx" or "010100xx" (smoke generator): Overheat protection: turns OFF from ½ min – about 2 hours. = 0: Won't turn off automatically. = 1 ... 252: Switches off automatically after 25 seconds/unit. Maximum time therefore is about 6300 sec. 105 min.

¹ Note to ditch lights: Ditch lights are only active when headlights and function F2 (#3 on Zimo cab) are on, which is prototypical for North American railroads. The ditch lights will only be working if the applicable bits in CV #33 and 34 are on (the definition in CV #125 - 128 in itself is not enough but a necessary addition). Example: If ditch lights are defined for F1 and F2, the bits 2 and 3 in CV #33 and 34 have to be set accordingly (i.e. CV #33 = 13 (00001101), CV #34 = 14 (00001110)).



3.15 Configuration of Electric Uncouplers

“System KROIS” and “System ROCO”

When one or two of the function outputs **FO1...FO6** (but not FO7 or FO8) are assigned to the uncoupler function (CV #127 for FO1 etc.), the control of the couplers as well as the entire uncoupling process is defined by the settings in

CV #115 and CV #116.

These CVs limit the pull-in time (to prevent overheating), define a hold-in voltage if required (i.e. System “Roco”) as well as the automated coupler unloading and train disengagement.

It is recommended to use the following settings for the **Krois system: CV #115 = 60, 70 or 80**; these settings will limit the pull-in voltage (full track power) to 2, 3 or 4 seconds respectively. A hold-in voltage is not required for the Krois coupler and the ones digit can therefore remain at “0”.

CV	Denomination	Range	Default	Description
#115	Uncoupler control “Pull-in” time and “hold” voltage or use CV #115 for an alternative second dim value	0 - 99	0	Uncoupler function is only active if “uncoupler” is selected (value 48) in one of the CVs #125...132: Tens digit (0 – 9): Time in seconds the coupler receives full voltage (pull-in time): Value: 0 1 2 3 4 5 6 7 8 9 seconds: 0 0,1 0,2 0,4 0,8 1 2 3 4 5 Ones digit (0 to 9): hold-in power in percent of track voltage, 0 - 90%. Applied after the pull-in time elapsed (necessary for ROCO coupler, not needed for KROIS coupler).

3.16 SUSI-Interface and Logic-Level Output

All decoders described in this manual (except for the MX681) have outputs that can either be used as a SUSI interface, as logic level outputs or for servo control. These outputs are available at solder pads or on the decoder plug (MTC or PluX), see the various decoder drawings starting on page 3.

These outputs are active by default as SUSI interface. They can be switched for the alternative applications with **CV #124** (Bit 7) or **CVs #181 and #182** (see next chapter “Servo configuration”).

CV	Denomination	Range	Default	Description
#124	Shunting key functions: Changing SUSI outputs	Bits 0 - 4, 6	0	Bits 0 - 4, 6: Shunting key selection and HALF-SPEED ACTIVATON Bit 7 = 0: SUSI active instead of normal functions = 1: Normal function outputs instead of SUSI

3.17 Servo Configuration

CV	Denomination	Range	Default	Description
#161	Servo outputs: Protocol	0 - 3 0 Note: CV #161 <u>must</u> be set to “2” for Smart Servo RC-1!	0	Bit 0 = 0: Servo protocol with positive pulses. = 1: Servo protocol with negative pulses. Bit 1 = 0: Control wire only active during movement = 1: ... always active (consumes power, vibrates at times but holds position even under mechanical load) – this setting is also required for SmartServo RC-1 (with memory wire)! Bit 2 = 0: Moves to center position, if defined for two-key operation (see CV #181/#182), when both function keys are OFF. = 1: Servo runs only if function keys are pressed when in two-key operating mode (see CV #181/#182). Bit 6 = 0: Servo1 for first address = 1: Servo1 for secondary address Bit 7 = 0: Servo2 for first address = 1: Servo2 for secondary address
#162	Servo 1 - Left stop	0 - 255	49 = 1 ms pulse	Servo's left stop position. “Left” may become the right stop, depending on values used.
#163	Servo 1 - Right stop	0 - 255	205	Defines the servo's right stop position.
#164	Servo 1 - Center position	0 - 255	127	Defines a center position, if three positions are used.
#165	Servo 1 - Rotating speed	0 - 255	30 = 3 sec	Rotating speed; Time between defined end stops in tenths of a second (total range of 25 sec, default 3 sec.).
#166 - #169	As above but for Servo 2			
#181 #182	Servo 1 Servo 2 Function assignment	0 - 28 90 - 93 101-114	0 0	= 0: Servo not in operation = 1: Single-key operation with F1 = 2: Single-key operation with F2 and so on to = 28: Single-key operation with F28 = 90: Servo action depends on loco direction: forward = turns left; reverse = turns right = 91: Servo action depends on loco stop and direction: turns right when stopped and direction is forward, otherwise turns left. = 92: Servo action depends on loco stop and direction: turns right when stopped and direction is reverse, otherwise turns left. = 93: Servo action depends on loco movement: turns right when loco stopped, left when loco moving; direction makes no difference.



				= 101: Two-key operation F1 + F2 = 102: Two-key operation F2 + F3 and so on = 111: Two-key operation F11 + F12 = 112: Two-key operation F3 + F6 = 113: Two-key operation F4 + F7 = 114: Two-key operation F5 + F8 (Two-key mode operates as defined with CV #161, Bit 2)
--	--	--	--	---

Connecting servos to decoder: *consult the loco decoder loco manual!*

3.18 Low-Voltage for Function Outputs (only function decoder MX675, MX676)

CV	Description	Range	Default	Description
#264	Setting output „low voltage“ of decoders MX675V..., MX676V..	decimal 0 - 7	0	= decimal 0: 1.5 V = decimal 1: 3 V = decimal 2: 5 V = decimal 3: 6.5 V = decimal 4: 12 V = decimal 5: 14 V = decimal 6: 16 V = decimal 7: 17 V

Optionally, the low voltage can also be set by solder bridges; see the connection diagrams of the MX675V, MX676V decoders in the chapter “technical information” to find further information.

The use of solder bridges has the advantage over the use of CVs that the setting is not lost even in the case of a hard reset; therefor this solution is preferred by model manufacturers who use the function decoders within their models to connect specified consumers such as low voltage lights or servos.

It is suggested to use only one of the two options (CV #264 or solder bridges) for low voltage settings

The combination of both is possible too: if the value of CV #265 is read binary (i.e. 3 = 0000 0011) the “1” mean the same as connected solder bridges (in case of 3 like X1 and X2). The low voltage results from OR-links of the solder bridges (X1, X2, X3) and the Bits 0, 1, 2 of the CV #264. The combination therefor always results in a higher voltage, i.e. CV #264 = 3 AND solder bridge X3 result in 17V.

4 Feedback - “Bidirectional communication”

All ZIMO decoder types have been equipped with a type of feedback ever since DCC was formed, which has always been a major difference to competitor products:

- the **ZIMO loco number identification** is part of ZIMO DCC decoders (not of ZIMO function decoders) since 1997 and as far back as 1990 with ZIMO’s own data format (which is no longer in use today). It can only be used with ZIMO DCC systems (MX1...MX10, MX31ZL, MX32ZL...) and together with ZIMO track section modules (MX9, StEin and successors): The decoder sends acknowledgment pulses after receiving DCC packets, which are utilized to identify and locate the decoder in the respective track section.
- the **“bidirectional communication”** according to **“RailCom”** is ready in all ZIMO decoders since 2004; in the later decoders such as the MX630, MX640 etc., it is operational since the beginning (basic functions and coming extensions).



“Bidirectional” means that the information transfer within the DCC protocol is not only flowing towards the decoder but also in the opposite direction; that is not just driving, function and switch commands are being sent to decoders but also messages such as acknowledgements, actual speed, other status information and CV read-outs are being received from decoders.

The functioning principle of RailCom is based on the introduction of short cut-outs (max. 500 micro seconds) to the otherwise continuously sent DCC signal by the command station. These cut-outs provide the time and opportunity for the decoders to send a few bytes of data to locally mounted detectors.

The RailCom relevant CVs are:

CV	Description	Range	Default	Description
#28	Bi-Directional Communication RailCom Configuration	0 - 3	3	Bit 0 - RailCom Channel 1 (Broadcast) 0 = OFF 1 = ON Bit 1 - RailCom Channel 2 (Data) 0 = OFF 1 = ON
#29	default Configuration Data #1	0 - 63	14 = 0000 1110 Which is Bit 3 = 1 (“RailCom” activated)	Bit 0 - Train direction: 0 = normal, 1 = reversed Bit 1 - Number of speed steps: 0 = 14, 1 = 28 Bit 2 - DC operation (analog): 0 = off 1 = on Bit 3 - RailCom (“bidirectional communication”) 0 = deactivated 1 = activated Bit 4 - Individual speed table: 0 = off, CV # 2, 5, 6, are active. 1 = on, according to CV 's # 67 – 94 Bit 5 - Decoder address: 0 = primary address as per CV #1 1 = ext. address as per CV #17+18

With the help of **bidirectional communication** according to RailCom or the alternative future method it will be possible that:

decoders can acknowledge received commands -

- which increases operational reliability and the bandwidth of DCC systems because already acknowledged commands don't need to be sent repeatedly;

up-to-date information is sent to the command station ("global detector") -

- e.g. "real" (measured) train speed, motor load, routing and position codes, "fuel reserves", current CV values, etc. are sent on demand from decoders to a command station or more precisely, to a **global detector** in the command station;

decoder addresses are recognized by "local" detectors -

- the actual loco positions are determined by local detectors connected to individual track sections (integrated in future track section modules), which has also been possible for over two decades with ZIMO's own loco number recognition (without RailCom), but only with ZIMO components.

RailCom will be further developed over the coming years and add new applications, which of course require new software updates in decoders and other equipment. All ZIMO decoders as of 2009 are able to send their own loco address from an insulated track section (with a so-called broadcast method, very fast, although only for one loco in that section), send CV content on demand along with some decoder data such as actual speed in km/h, load and decoder temperature.

RailCom in ZIMO Decoders is activated with

CV #29, Bit 3 = 1 AND CV #28 = 3

These are usually default settings on a new decoder, but RailCom is turned off by default in many sound projects or OEM CV sets and must therefore be activated first with the CVs mentioned above.

"RailCom" is a registered trademark of Lenz Elektronik GmbH.

5 Operating with Märklin MOTOROLA Systems

See loco decoder manual (MX small decoders)

6 ZIMO Decoder - Software Update

See MXULF manual

7 Calculation of the long second loco address:

Programming the second loco address works like for the first address, except that for the first, the system automatically calculates the corresponding values for CVs #17 & #18. CVs #67 & #68 have to be calculated by the user. This is done with the following formula:

CV 67 = desired address / 256 (only the digits BEFORE the point) + 192

CV 68 = desired address - ((CV 67 - 192) * 256)

Example: the **desired address** is **10111**:

CV 67 = 10111/256 +192 = 39+192 = **231**

CV 68 = 10111-[(231-192)*256] = 10111-(39*256) = 10111-9984 = **127**

Alternatively, it is possible to program the desired long second address into CVs #17 & #18 (for the first address) and have the system convert it. Then write the converted values of CV #17 & #18 into CVs #67 & #68. Afterwards, the user has to reprogram the first long address (if it was used).

The calculation of the long second address for CV #17 and #18 can also be done with this online calculator: www.opendcc.de/info/decoder/dcc_cv.html (scroll down to CV #17,18)

8 Service Notes

Even ZIMO decoders can break down ... sometimes "for no reason", sometimes due to short circuits in the wiring, sometimes by a failed update ...

These defective decoders can of course be sent to ZIMO for repair or replacement. Whether this is covered by warranty or a payable service, the submitter should expect a decoder back that is not only functional, but is also configured similarly as the original (i.e. the same CV values and the same sound project). However, this is not possible if the decoder is damaged so badly that it cannot be read-out anymore.

Therefore it is **recommended** to **READ OUT IMPORTANT DATA** from the decoder before it is defective and to send this information along with the decoder to ZIMO for repair:

- Address
- Loaded SW version (CV #7, 65)
- Possibly activated CV Set (activation code for CV #8, concerns non-sound decoder)
- Decoder ID (CV #250 ... 253, if available)
- Possibly load code (CV #260 ... 263, relates to sound decoder)
- Loaded sound project.

It would also be **very useful** (but relatively complex) to read out the entire CV list and keep it in a safe place, so it can later be programmed to a repaired decoder (which sometimes requires a hard-reset) or a replacement. Reading out and reprogramming decoders is easy with the help of

- program "ADaPT" (from E.Sperrer, works with Zimo and some other DCC systems)
- ZSP (works with MX31ZL MXDECUP or, in the future, with MXULF or MX10) or with
- ZSC (works with MXULF and in the future with MX10).

